

# User Manual

## AGC & ASC Satellite & Cable Amplifier

Ref. 9658

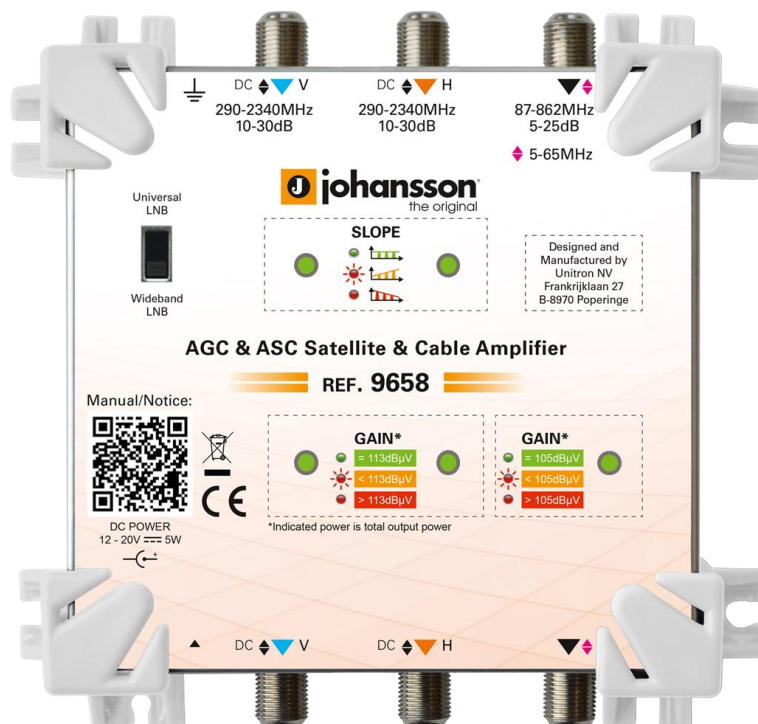

## CONTENTS

<b>1. INTRODUCTION .....</b>	<b>3</b>
Product description .....	3
Package contents .....	3
<b>2. INSTALLATION .....</b>	<b>4</b>
<b>3. CONFIGURATION OF THE PRODUCT .....</b>	<b>5</b>
LNB switch: .....	5
Indication LEDs: .....	5
<b>4. TECHNICAL SPECIFICATIONS .....</b>	<b>6</b>
<b>5. SAFETY INSTRUCTIONS .....</b>	<b>7</b>
<b>6. CONDITIONS OF WARRANTY.....</b>	<b>8</b>

No part of this manual may be copied, reproduced, transmitted, transcribed or translated into any language without permission.

Unitron reserves the right to change the specifications of the hardware and software described in these manuals at any time.

Unitron cannot be held liable for any damages resulting from the use of this product. Specifications are subject to change without notice. 5/21

© Unitron NV - Frankrijklaan 27 - B-8970 Poperinge - Belgium

T +32 57 33 33 63 F +32 57 33 45 24

sales@unitrongroup.com

www.unitrongroup.com

# 1. INTRODUCTION

## Product description

The AGC & ASC Satellite & Cable Amplifier optimizes your Wideband V/H (290-2340 MHz) and Cable (87-862MHz) signal in real-time.

To do so, it uses Automatic Gain Control (AGC) and Automatic Slope Control (ASC).

- Automatic Gain Control on all lines (V/H/Cable) and Automatic Slope Control on both satellite lines (V/H)
- DC input for powering amplifier and LNB (Optional power supply (ref. 9933))
- Selectable between Wideband LNB (290 - 2400 MHz) and Universal LNB (950 - 2150 MHz)

## Package contents

1x REF.9658 AGC & ASC Satellite & Cable Amplifier

## 2. INSTALLATION

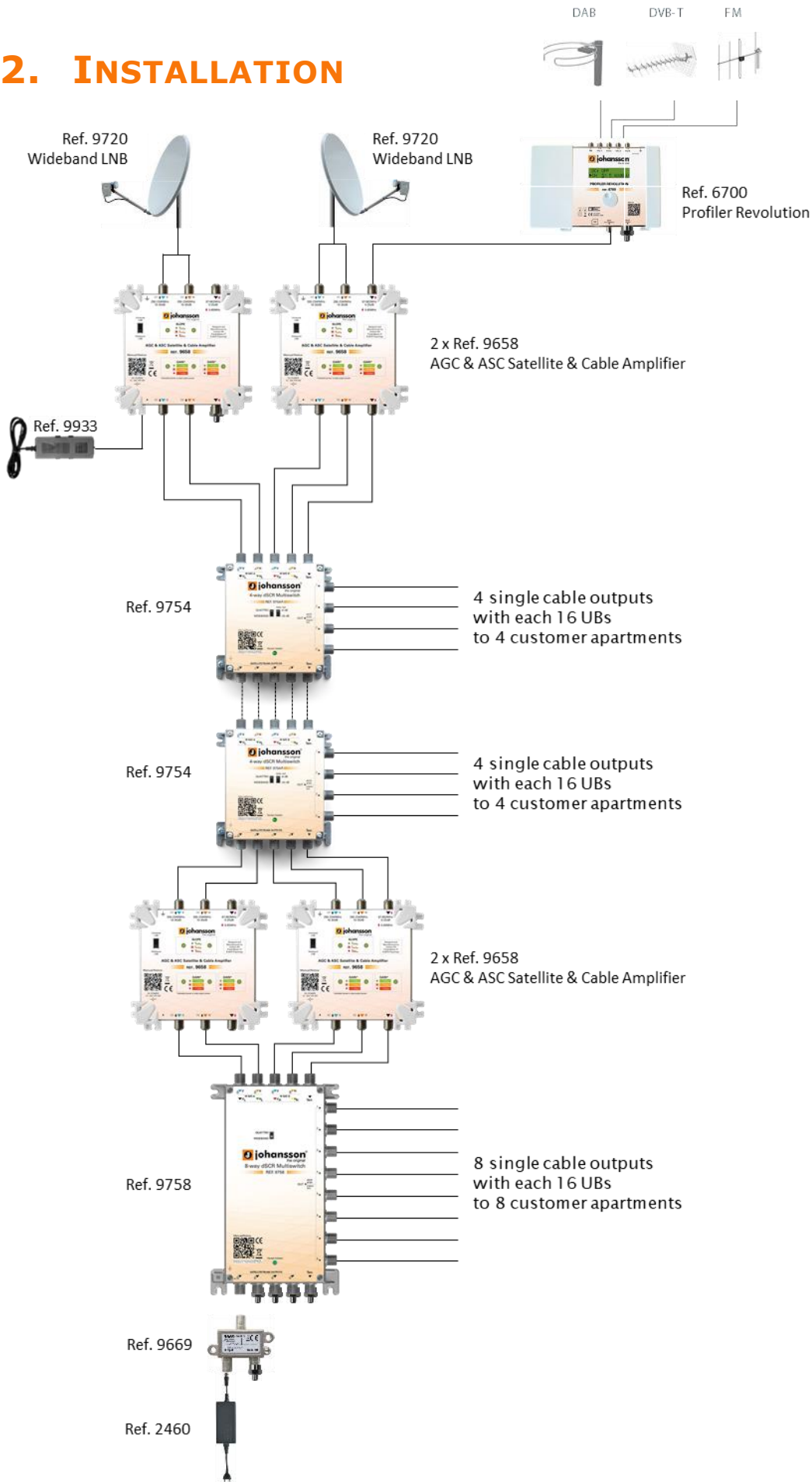

### 3. CONFIGURATION OF THE PRODUCT

#### LNB switch:



The **LNB switch** lets you select the type of LNB used in your installation. The LNB selection defines the slope frequency range:  
 Wideband LNB: 300-800MHz Universal LNB: 950-1300MHz.

#### Indication LEDs:

**SLOPE LEDS** (LED on left is for Sat V input, LED on right is for Sat H input)

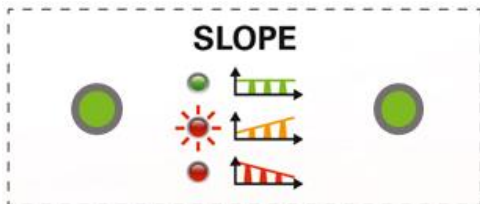

**SOLID RED:** signal too strong: cable to short, move the amplifier further away from the source

**BLINKING RED:** signal too low: cable too long, move the amplifier more close to the source

**SOLID GREEN:** within range, signal level has the correct level

**GAIN LEDS** (LED on left is for Sat V input, LED in middle is for Sat H input, LED on right is for Cable input)

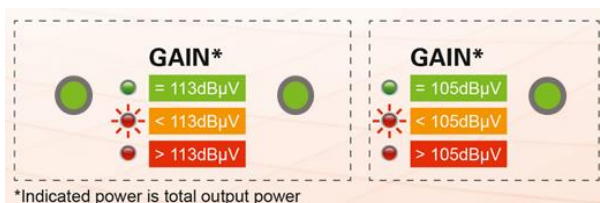

\*Indicated power is total output power

**SOLID RED:** signal too strong: cable to short, move the amplifier further away from the source

**BLINKING RED:** signal too low: cable too long, move the amplifier more close to the source

**SOLID GREEN:** within range, signal level has the correct level

BOTH GAIN and SLOPE LED should be green to guarantee that the average output level has the correct level, generally speaking RED LED (regardless its state) is not a good situation and its advisable to take steps described above



## 4. TECHNICAL SPECIFICATIONS

9658				
Inputs	-	SAT V	SAT H	CABLE
Outputs	-	SAT V	SAT H	CABLE
Frequency range	MHz	290 – 2400 (Wideband) 950 – 2150 (Universal)		87 – 862
Gain	dB	10 – 30	10 – 30	5 – 25
Noise figure	dB	5		
Gain adjustment	dB	20 (Automatic Gain Control)		
Slope adjustment	dB	15 (Automatic Slope Control)		-
Output level	dB $\mu$ V	113		105
Cable Return Path	MHz	-	-	5 - 65
Consumption	-	400 mA max. from 12-20 VDC external power supply or input / output		
Power Consumption	W	5		
Dimensions	mm	129 x 140 x 51		
Weight	kg	0.350		

## 5. SAFETY INSTRUCTIONS





**Read these instructions carefully before connecting the unit**

-  To prevent fire, short circuit or shock hazard:
  - Do not expose the unit to rain or moisture.
  - Install the unit in a dry location without infiltration or condensation of water.
  - Do not expose it to dripping or splashing.
  - Do not place objects filled with liquids, such as vases, on the apparatus.
  - If any liquid should accidentally fall into the cabinet, disconnect the power plug.
  
-  To avoid any risk of overheating:
  - Install the unit in a well aery location and keep a minimum distance of 15 cm around the apparatus for sufficient ventilation
  - Do not place any items such as newspapers, table-cloths, curtains, on the unit that might cover the ventilation holes.
  - Do not place any naked flame sources, such as lighted candles, on the apparatus
  - Do not install the product in a dusty place
  - Use the apparatus only in moderate climates (not in tropical climates)
  - Respect the minimum and maximum temperature specifications
  
-  To avoid any risk of electrical shocks:
  - Connect apparatus only to socket with protective earth connection.
  - The mains plug shall remain readily operable
  - Pull out power plug to make the different connections of cables
  - To avoid electrical shock, do not open the housing of adapter.



**Maintenance**

-  Only use a dry soft cloth to clean the cabinet.
-  Do not use solvent
-  For repairing and servicing refer to qualified personnel.



**Dispose according your local authority's recycling processes**

## 6. CONDITIONS OF WARRANTY

Unitron N.V. warrants the product as being free from defects in material and workmanship for a period of 24 months starting from the date of production indicated on it. See note below.

If during this period of warranty the product proves defective, under normal use, due to defective materials or workmanship, Unitron N.V, at its sole option, will repair or replace the product. Return the product to your local dealer for reparation.

### **THE WARRANTY IS APPLIED ONLY FOR DEFECTS IN MATERIAL AND WORKMANSHIP AND DOES NOT COVER DAMAGE RESULTING FROM:**

- Misuse or use of the product out of its specifications,
- Installation or use in a manner inconsistent with the technical or safety standards in force in the country where the product is used,
- Use of non-suitable accessories (power supply, adapters...),
- Installation in a defect system,
- External cause beyond the control of Unitron N.V. such as drop, accidents, lightning, water, fire, improper ventilation...

### **THE WARRANTY IS NOT APPLIED IF**

- Production date or serial number on the product is illegible, altered, deleted or removed.
- The product has been opened or repaired by a non-authorized person.

### **NOTE**

Date of production can be found in the product's serial number code. The format will either be "YEAR W WEEK" (e.g., 2017W32 = year 2017 week 32) or "YYWW" (e.g., 1732 = year 2017 week 32).



[www.unitrongroup.com](http://www.unitrongroup.com)

**UNITRON NV**  
**Frankrijklaan 27**  
**B-8970 Poperinge**  
**Belgium**

**T +32 57 33 33 63**  
**F +32 57 33 45 24**

[sales@unitrongroup.com](mailto:sales@unitrongroup.com)

[www.unitrongroup.com](http://www.unitrongroup.com)